

LET
LIGHT
ALULED
LIVE

 SCANGIFT®

WWW.SCANGIFT.COM

ALULED square collection

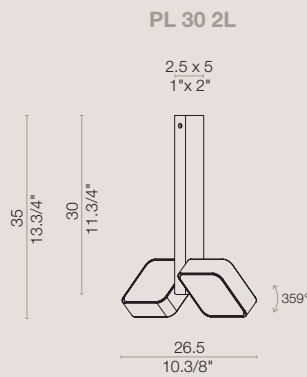
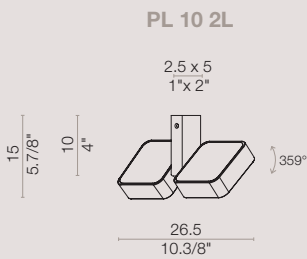
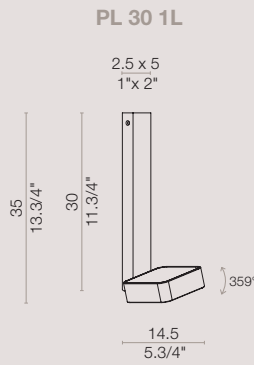
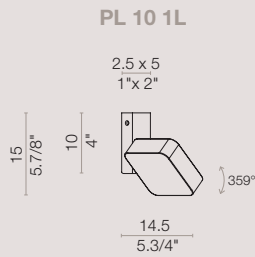
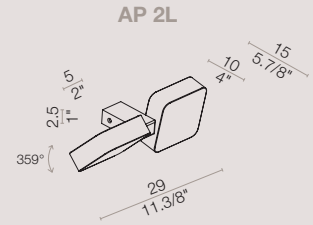
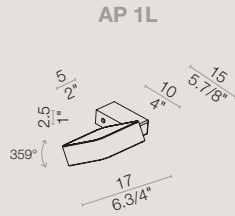
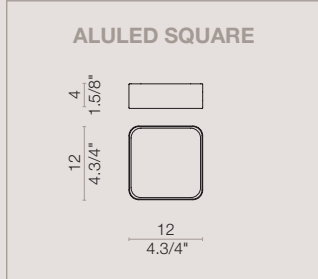

PROJECT:

TYPE:

MODEL #

FINISH/COLOUR

WATTAGE

LIGHT SOURCE

VOLTAGE



[En] → Lighting fixture in carved solid aluminium, powder-coated available in 4 colors and concrete finish. White PMMA diffuser. LED 220-240V. 359° adjustable version as wall/ceiling lamp. Frame in powder-coated aluminium, available in 4 colors. Chromed metal joint.

[It] → Corpo illuminante in alluminio ricavato dal pieno verniciato a polveri nei 4 colori disponibili e finitura cemento. Diffusore in PMMA bianco. Sorgente LED 220-240V. Versione orientabile 359° parete e plafoniera. Montatura in alluminio verniciato a polveri nei 4 colori disponibili. Snodo metallo cromato.

material

aluminium
alluminio

light source

LED 220-240V

120V for
NORTH AMERICA

Dimmer not included
Dimmer non incluso

equipment

AP 1L / PL 10 - 30 - 70 1L
21W LED 3000°K lm1850

AP 2L / PL 10 - 30 - 70 2L
42W LED 3000°K lm3700

symbols

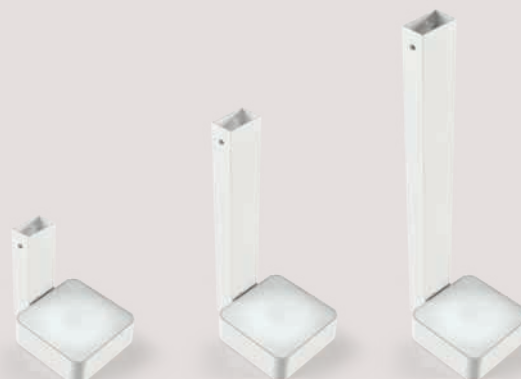
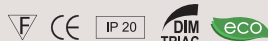

photometric test SQUARE

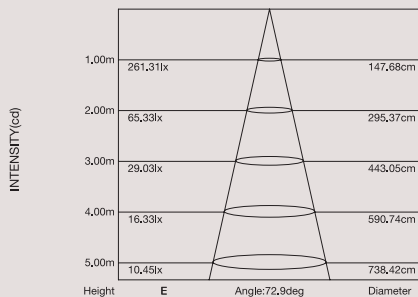
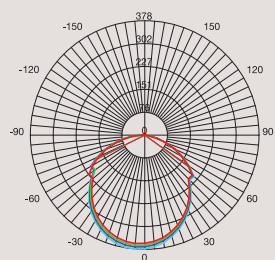

colors



white / bianco
RAL 9010



dove / tortora
RAL 1019



grey / grigio
RAL 7031



black / nero
RAL 9005



concrete /
cemento



AP 1L
wall lamp

dimensions
W 17 x DPT 15 cm

colors
white 9010 + dove 1019

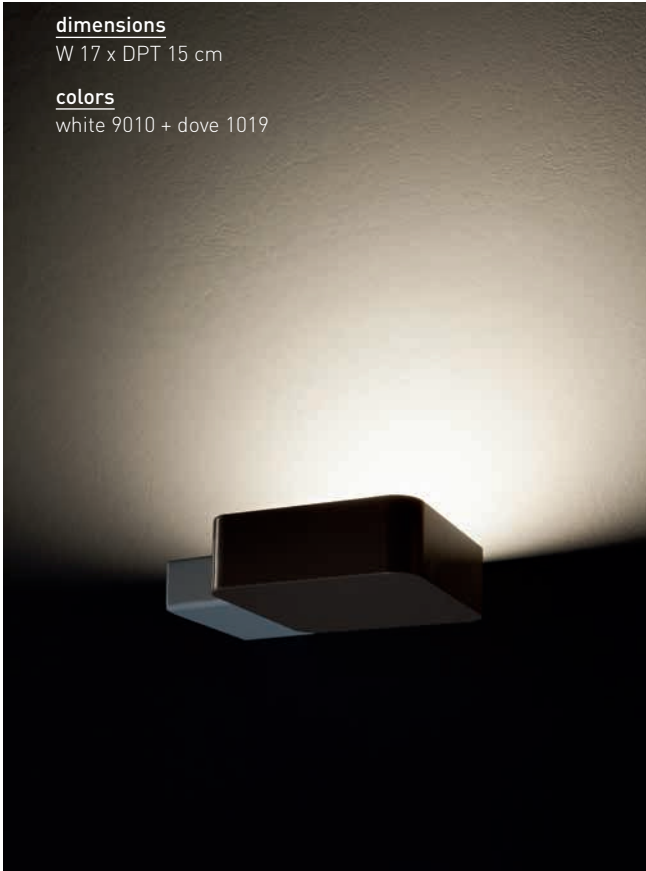

ALULED
→ **square**

[En] → ALULED SQUARE is composed of a square element, a pure and regular shape softened by rounded edges. The lighting fixture is assembled in a single or double version with a powder coated aluminium support allowing installation of the fixture either on ceilings or on walls.

[It] → ALULED SQUARE, si compone di un elemento quadrato dalla forma pura e regolare ingentilita dall'arrotondamento degli spigoli. Il corpo illuminante è applicato, in versione singola o doppia a un supporto in alluminio verniciato a polveri consentendo l'utilizzo della lampada sia a soffitto che a parete.



PL 30 1L
ceiling lamp

dimensions
L 14.5 x H max 35 cm

color
dove 1019



PL 70 2L
ceiling lamp

dimensions
L 26,5 x H max 75 cm

colors
white 9010 + dove 1019



[En] → The chrome plated joints of ALULED SQUARE allow a 359° independent rotation of the lighting fixtures. The fixtures are assembled with a powder coated aluminium support available in three different lengths.

[It] → Gli snodi cromati di ALULED SQUARE, consentono la rotazione indipendente di 359 gradi dei corpi illuminanti. Questi ultimi, sono applicati ad un supporto in alluminio verniciato a polveri disponibile in tre lunghezze.





ALULED square

PL 30 2L
ceiling lamp

dimensions
L 26.5 x H max 35 cm

colors
grey 7031 + white 9010

[En] →

The precision given by CNC machining, which is used to manufacture both the precision fixed aluminium carved solid aluminium and the PMMA diffuser, allow the fixing system of the two parts with no visible mechanical elements.

a controllo numerico, con cui vengono prodotti sia il corpo illuminante ricavato da un pieno in alluminio, sia il diffusore in PMMA, permettono un fissaggio delle due parti, privo di elementi meccanici a vista.

ALULED square

PL 30 1L
ceiling lamp

dimensions
L 14,5 x H max 35 cm

colors
grey 7031 + white 9010

