

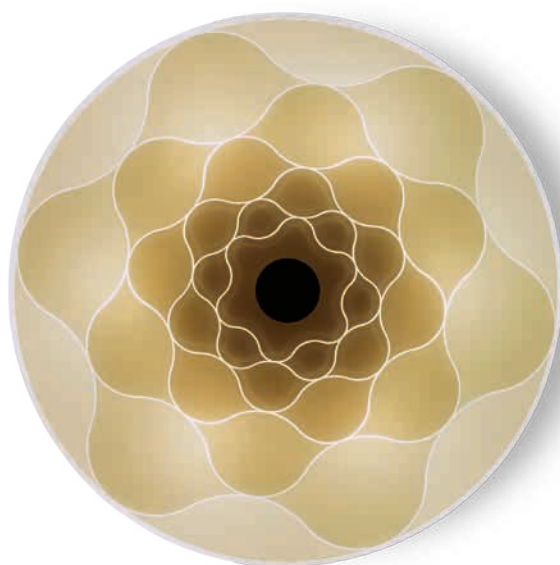

**DROP
LIGHT
RIPPLE
BIG**



ON



OFF

[En] → When the lighting fixtures is off, the surface of the silkscreened glass diffuser looks like an even white surface, and you can see only the outlines of the floral decoration. When on, the surface is alive with different color shades, due to the number of silkscreen layers. Along the outline of the decoration, the light is clearer because there is less color; instead towards the center, where there is more color, the intensity of light decreases.

[It] → La superficie serigrafata del diffusore in vetro piano, quando la lampada è spenta, si presenta come una superficie omogenea bianca in cui si notano solo i contorni del decoro floreale. Con la luce, la superficie si anima di diverse tonalità determinate dalla quantità di strati di serigrafia. Lungo il perimetro, la luce è più chiara poichè minore è l'apporto di colore, mentre verso il centro, dove questo è maggiore, diminuisce l'intensità luminosa.

PROJECT:

TYPE:

MODEL #

FINISH/COLOUR

WATTAGE

LIGHT SOURCE

VOLTAGE

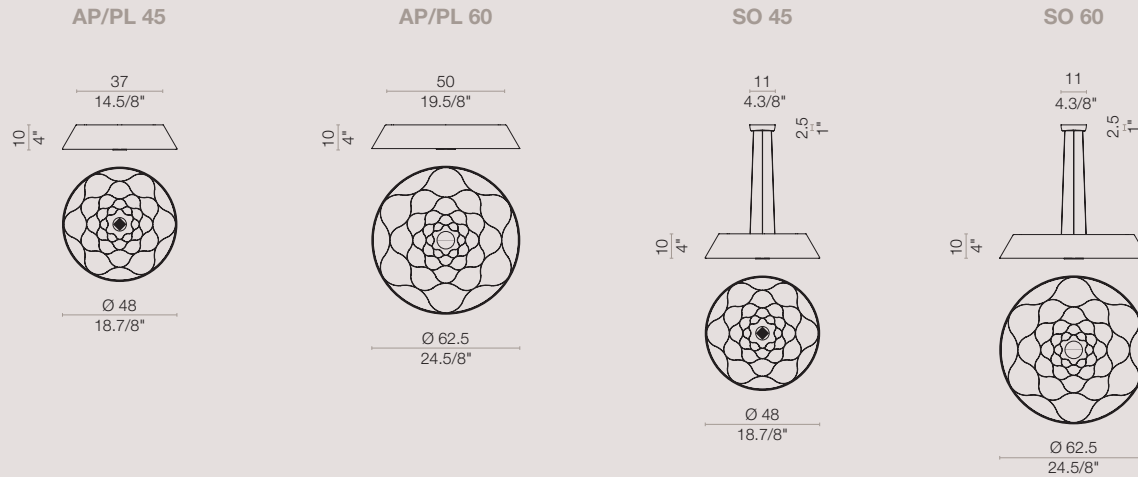

[En] → Flat panel glass front diffuser, with multi-layer silkscreened décor. Prismatic thermoformed PMMA side diffuser, detail in polished carved solid aluminium. LED 220-240V.

[It] → Diffusore frontale in vetro piano con decoro serigrafato multistrato. Diffusore laterale in PMMA prismatico termoformato, particolare in alluminio lucido ricavato dal pieno. Sorgente LED 220-240V.

material

Glass and PMMA
Vetro e PMMA

light source

LED 220-240V

120V for
NORTH AMERICA

Dimmer not included
Dimmer non incluso

equipment

AP/PL 45
38W LED 3000°K Im3000

AP/PL 60
57W LED 3000°K Im4500

SO 45
38W LED 3000°K Im3000

SO 60
57W LED 3000°K Im4500

symbols



photometric test DROP PL 60

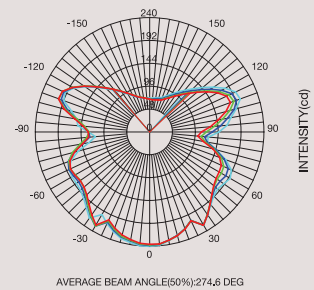



DROP *collection*

[En] → **A drop in the sea.** Like a stone thrown into water stirs waves and reverberation, light transforms and brings DROP to life. The glass diffuser, decorated by several layers of serigraphy, gives the product a decoration that can only be seen when the lamp is illuminated. The diffuser is also wrapped in a structural prismatic PMMA element that spreads the light in a uniform manner all around.



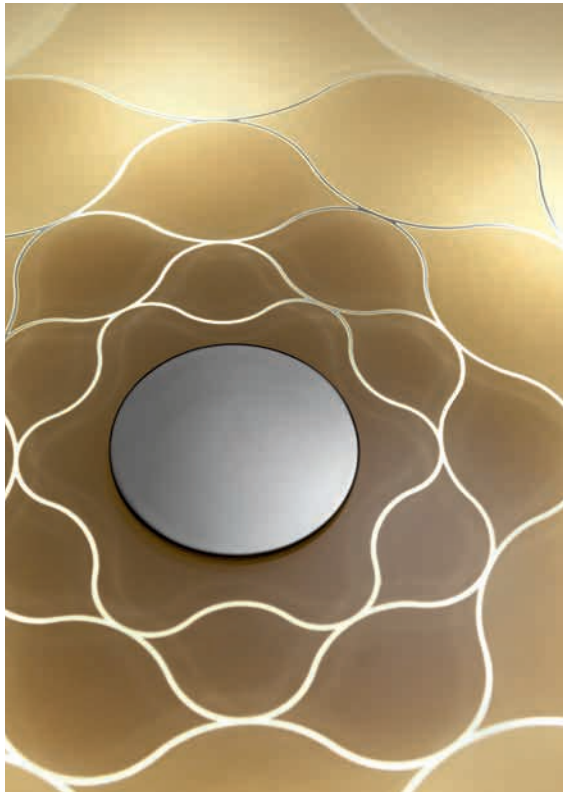

DROP

SO 45
suspension

dimensions
Ø 48 x H 10 cm



SCANGIFT®

WWW.SCANGIFT.COM

[En] → The prismatic thermoformed PMMA element in the hanging lamp allows the diffusion of indirect light to the top and to the sides. It is also the real structural element of the lighting fixture on which the silkscreened glass diffuser and the hanging kit are fixed.

[It] → L'elemento in PMMA prismatico termoformato, nella versione a sospensione, consente la diffusione della luce verso l'alto e i lati. Esso inoltre, è il vero e proprio elemento strutturale della lampada su cui sono fissati il diffusore in vetro serigrafato e il kit di sospensione.

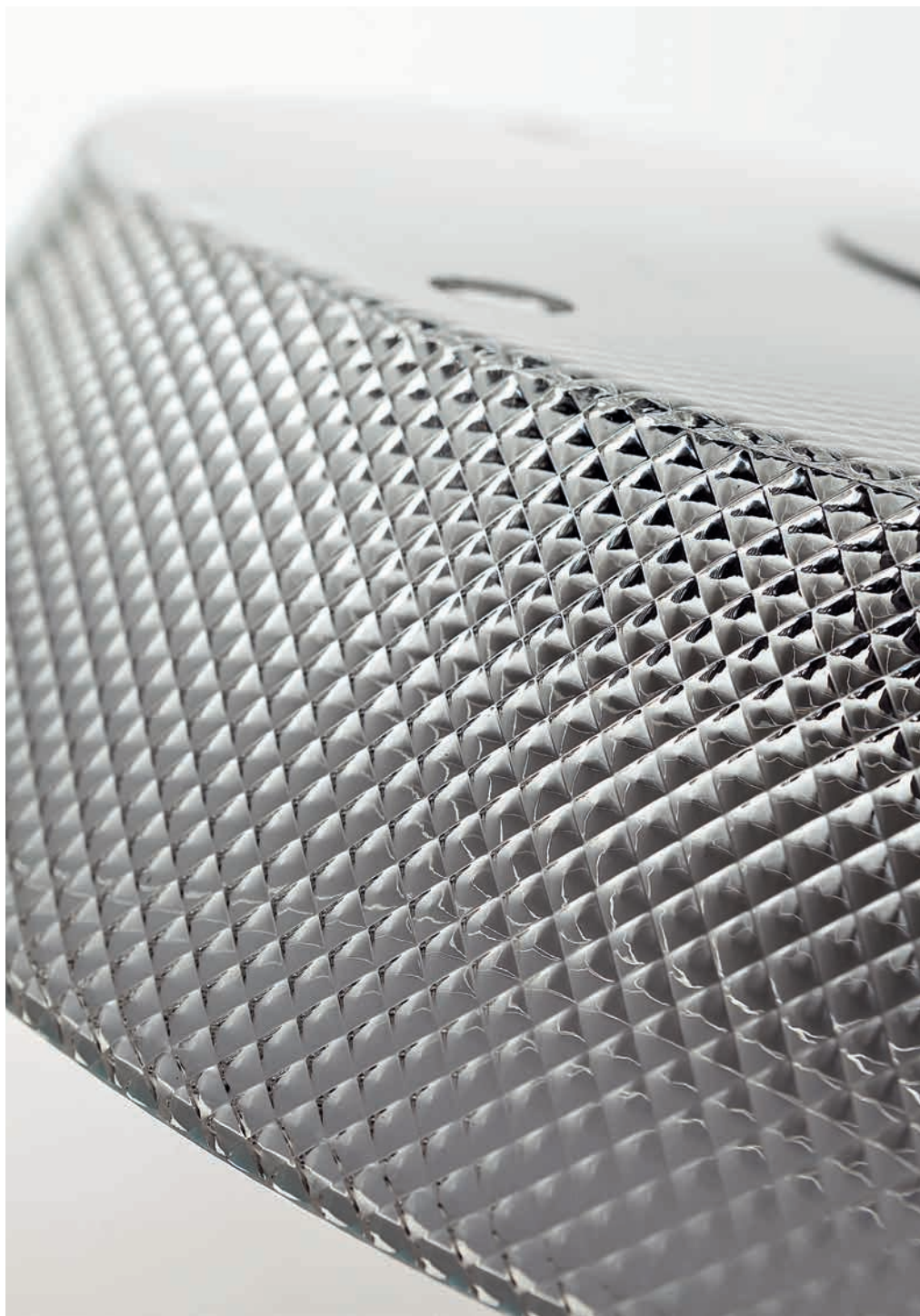
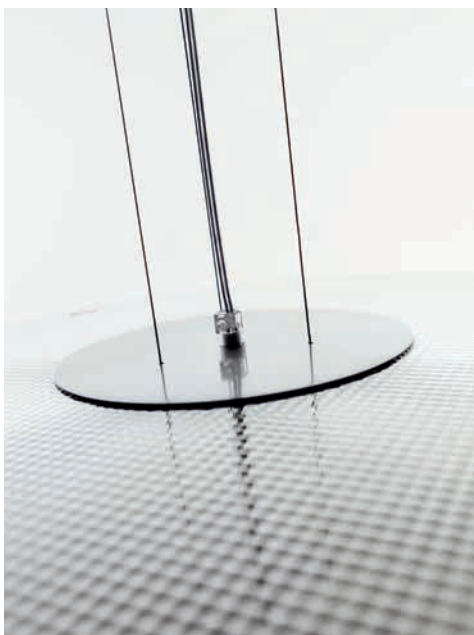

DROP

AP/PL 60

wall or ceiling lamp

dimensions

Ø 62.5 x DPT 10 cm



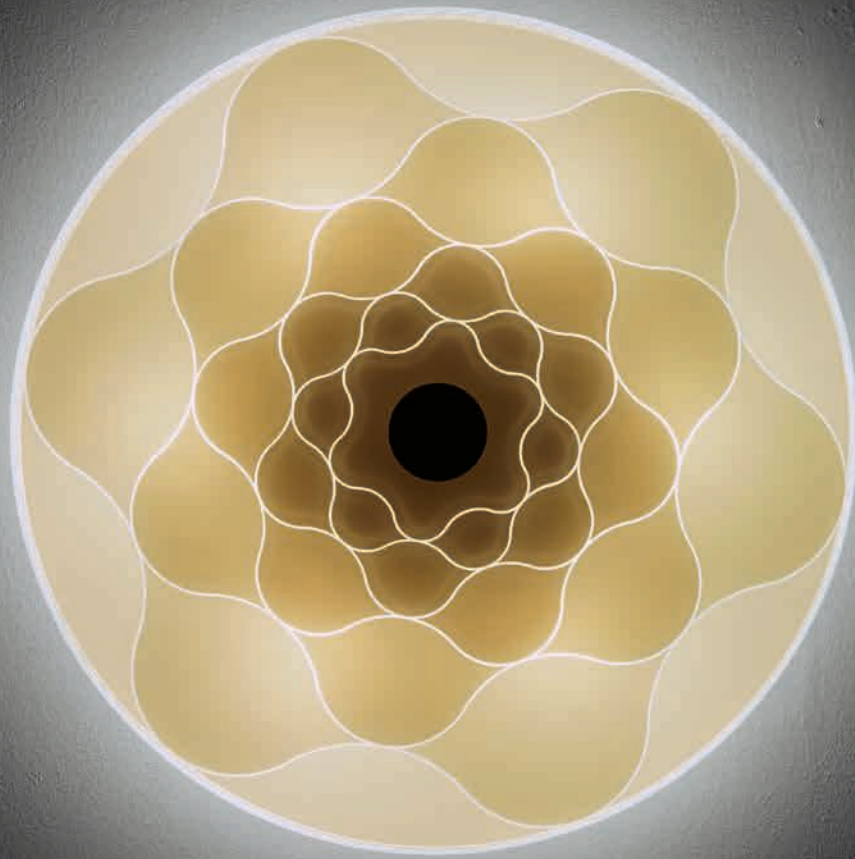

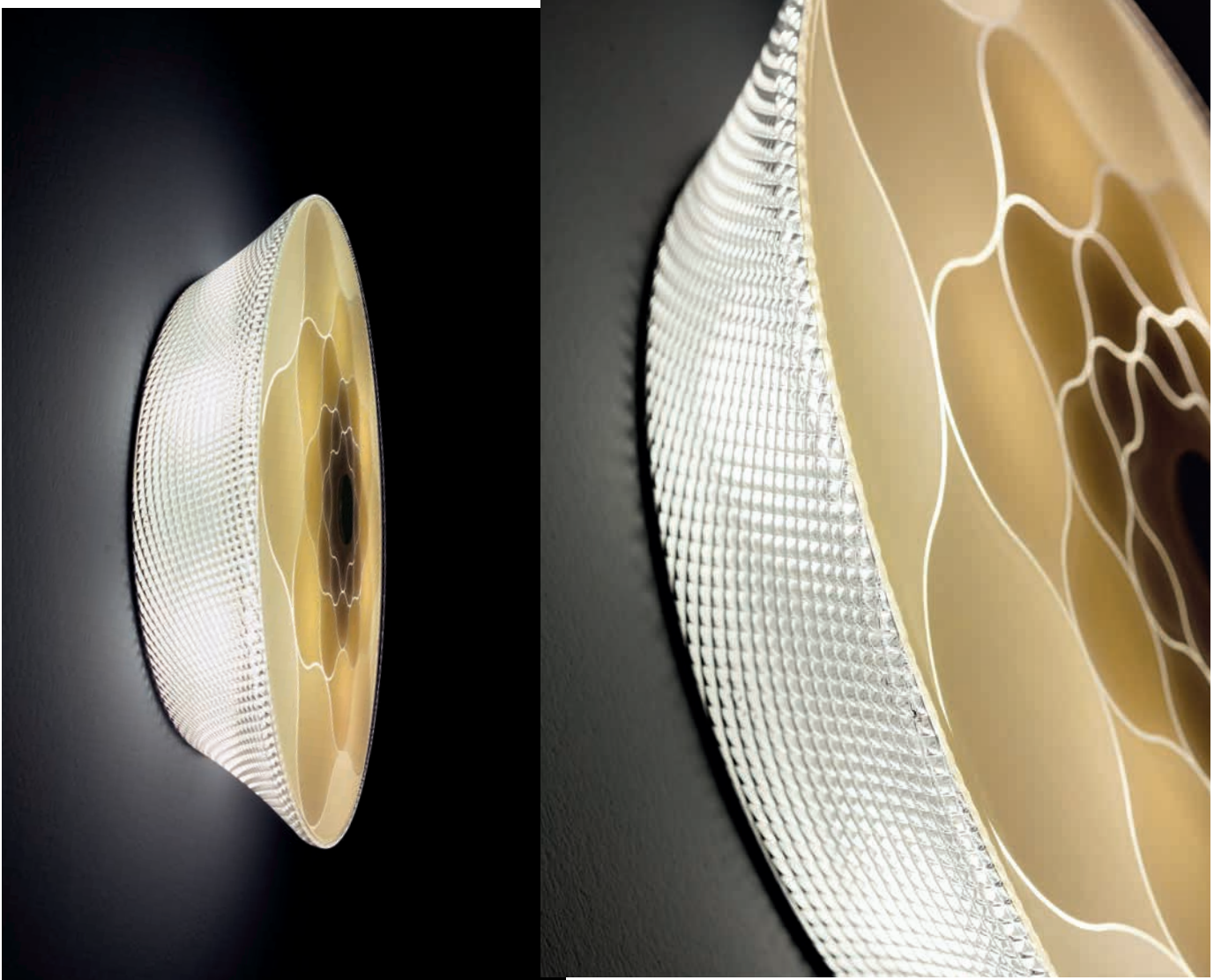

DROP

AP/PL 45

wall or ceiling lamp

dimensions

Ø 48 x DPT 10 cm

